

THESE INSTRUCTIONS SHOULD ONLY BE PRINTED USING ADOBE ACROBAT AND SHOULD NOT BE FAXED OR REPRODUCED ON A DIGITAL COPIER. AMERICAN WOODMARK CORPORATION PROVIDES THESE INSTRUCTIONS ON AN "AS IS" BASIS AND DISCLAIMS ANY AND ALL LIABILITY FOR ANY INACCURACIES, OMISSIONS OR TYPOGRAPHICAL ERRORS CAUSED BY THE USER'S EQUIPMENT OR BY ANY THIRD PARTY'S EQUIPMENT.

ESTAS INSTRUCCIONES SOLO SE DEBEN IMPRIMIR USANDO ADOBE ACROBAT Y NO SE DEBEN ENVIAR POR FAX NI SE DEBEN REPRODUCIR EN UNA COPIADORA DIGITAL. AMERICAN WOODMARK CORPORATION PROPORCIONA ESTAS INSTRUCCIONES "TAL COMO ESTAN" Y RENUNCIA A CUALQUIER Y A TODA RESPONSABILIDAD POR CUALQUIER FALTA DE PRECISION, OMISION O ERROR TIPOGRAFICO CAUSADO POR EL EQUIPO DEL USUARIO O POR EL EQUIPO DE TERCERAS PERSONAS.

432 Series Filler Pull-Out Instructions
Instrucciones del armario de relleno deslizante – Serie 432
Directives de montage du module coulissant série 432



REV-A-SHELF®



Fig 1

Step 1. Measure scribe rail thickness and length per your specific cabinetry. See Fig 1

Step 3. Install rear scribe rail between upper and lower scribe rails on the back edge of the filler chassis. **NOTE:** The back edge of the filler chassis should be flush with the back edge of the rear scribe rail. (See Fig 4).

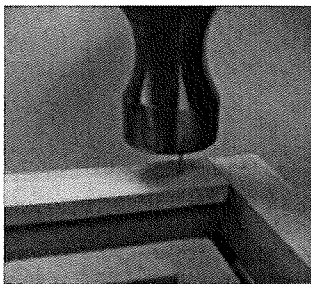

Fig 4

Fig 3
Base Cabinet



Step 2. Install upper and lower scribe rails to filler pull-outs using small finish nails or brads. See Fig 2. **Note:** Align scribe rails with front edge of filler pull-outs. Align scribe rail to upper section of base cabinet lower mounting strap. See Fig. 3.

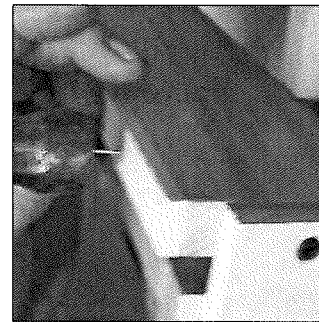
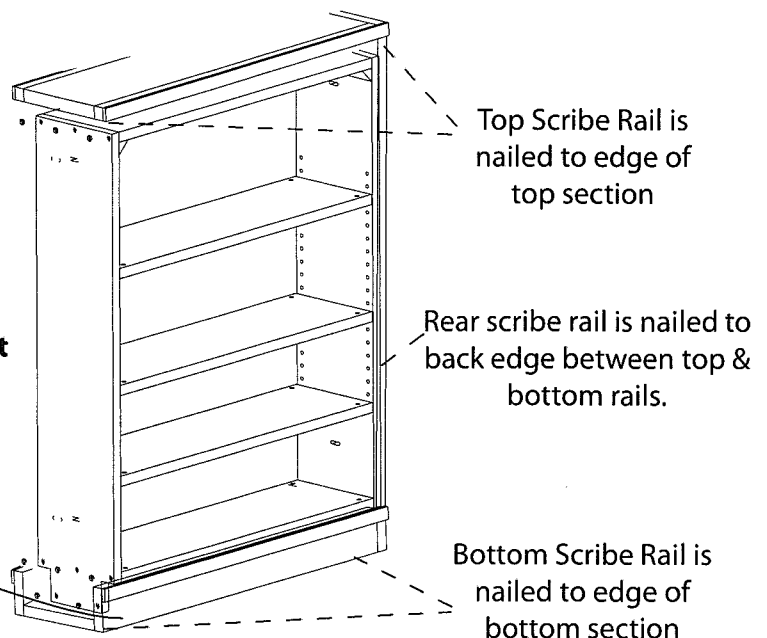

Fig 2



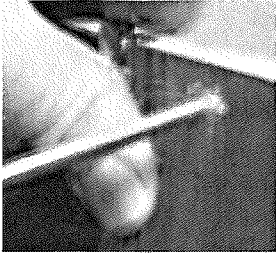

Fig 5a

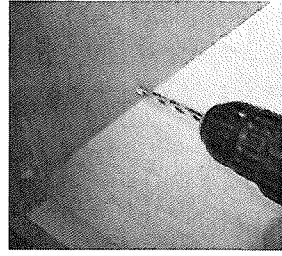

Fig 5b

Step 4. Pre-drill 3/16 inch holes 3/8 inch down from from top of cabinet and also 27-3/4" down from top of cabinet. (See Fig 5a-c). Repeat with other adjacent cabinet.

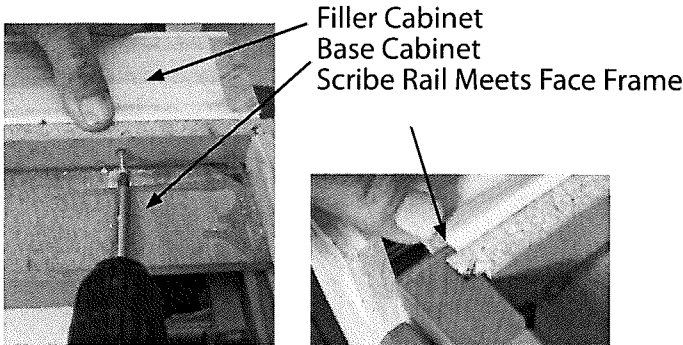
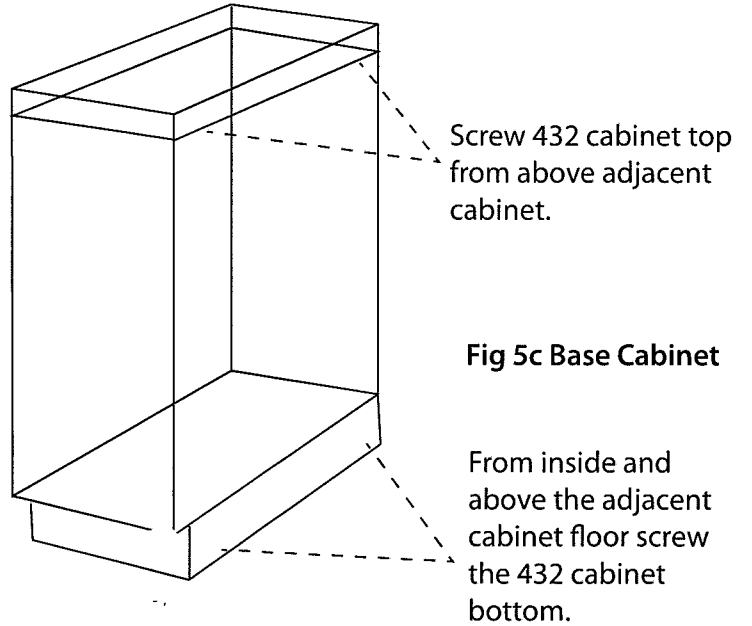

Fig 6a

Fig 6b

Step 5. Mount filler cabinet pull-out to adjacent cabinet 1. See Fig. 6a-b

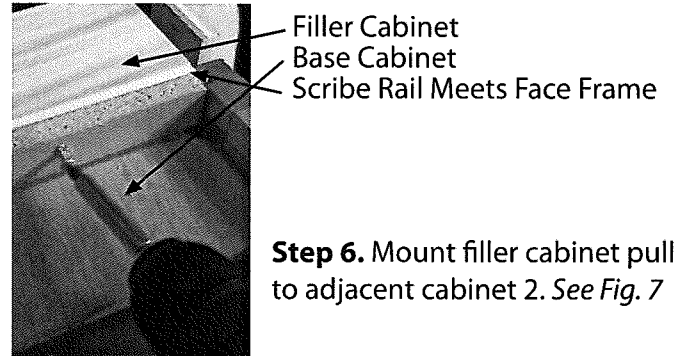

Fig 7

Step 6. Mount filler cabinet pull-out to adjacent cabinet 2. See Fig. 7

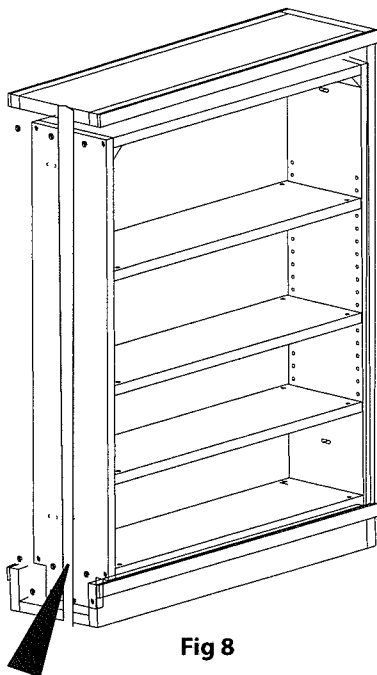

Fig 8

Step 7. Remove front mounting strap. See Fig 8.



Fig 9

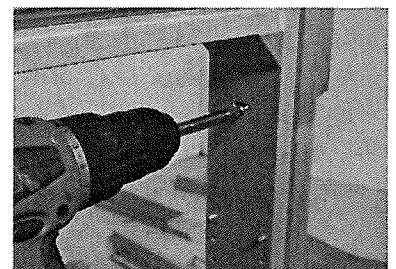

Fig 10

10-0584-03B VS-41

Step 8. Attach face frame and onlays (not provided) See Fig. 9-10.

REV·A·SHELF®



Fig 1

Paso 1. Mida el grosor y la longitud de los rieles ajustables para sus armarios particulares. Ver la figura 1.

Paso 3. Instale el riel trasero entre y superior riel del más bajo en el borde trasero del chasis del llenador. **Nota:** El borde trasero del chasis del llenador debe ser plano con el borde trasero del riel trasero (Ver la fig 4)

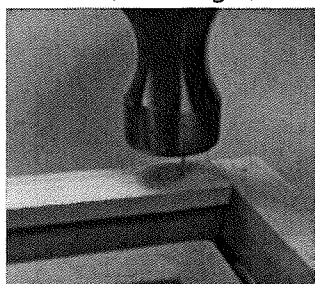

Fig 4

Paso 2. Instale los rieles ajustables en los armarios de relleno deslizantes utilizando clavos para acabado o puntillas. Ver la figura 2. **Nota:** Haga coincidir los rieles ajustables con el borde delantero del armario de relleno deslizante. Alinee el riel ajustable con las secciones superiores de la banda de montaje inferior del armario-base. Ver las figuras 3

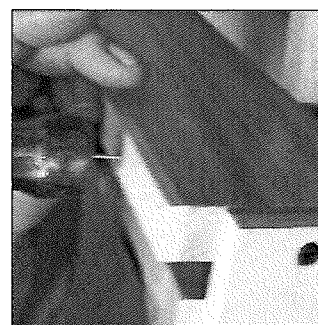
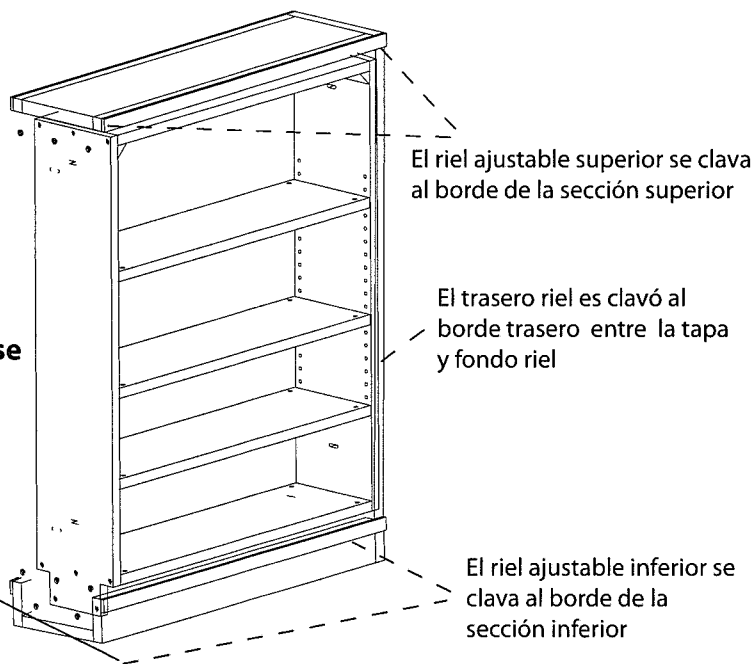

Fig 2

Fig 3
Armario-base



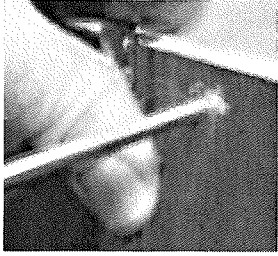

Fig 5a

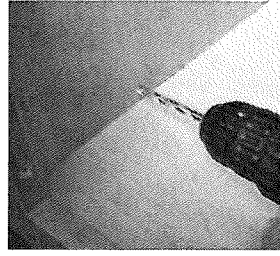
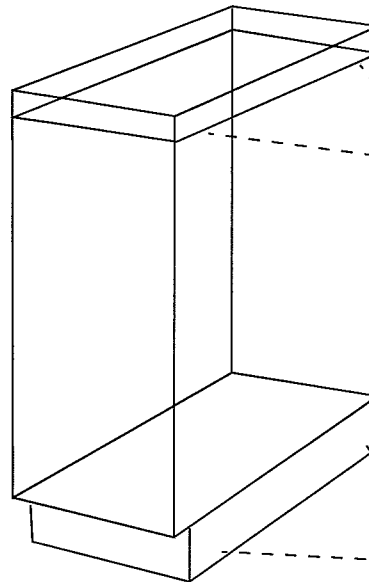

Fig 5b

Paso 4. Taladre orificio de 3/16 pulg. a 3/8 pulg. y 27-3/4 pulg. por debajo de la parte superior del armario. (Ver las figuras 5a-c.) Repita el proceso en el armario contiguo.



Atornille la parte superior del armario 432 desde la parte superior del armario contiguo

Fig 5c Armario-base

Atornille la parte inferior del armario 432 desde adentro y arriba del piso del armario contiguo.

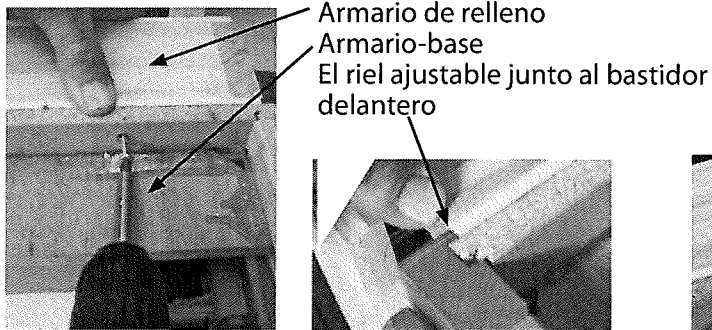

Fig 6a

Fig 6b

Paso 5. Monte el armario de relleno deslizante en el armario 1. Ver las figuras 6a-b.

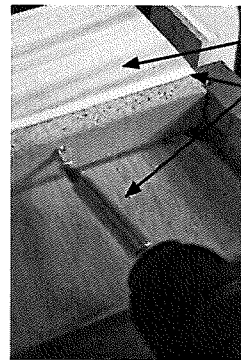

Fig 7

Armario de relleno
Armario-base
El riel ajustable junto al bastidor delantero

Paso 6. Monte el armario de relleno deslizante en el armario 2. Ver la figura 6.

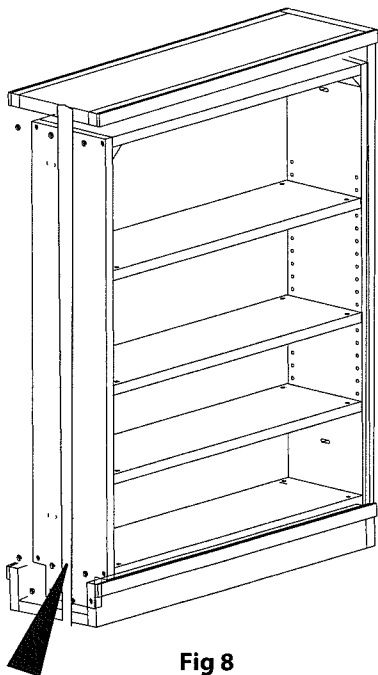

Fig 8

Paso 7. Retire la banda de montaje delantera. Ver las figuras 8.



Fig 9

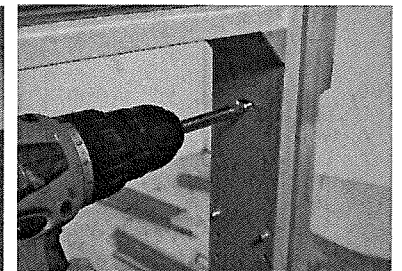

Fig 10

Paso 8. Instale el bastidor delantero y las chapas (no se incluyen). 10-0584-04B VS-41